

6850

col
lines
rockel
yellow
TOP

- 17125 20 VIDEO CT1
- 17126 20 VIDEO CT2
- 17127 20 VIDEO CT3
- 17128 20 VIDEO CT4
- 17129 20 VIDEO CT5
- 17130 20 VIDEO CT6
- 17131 20 VIDEO CT7
- 17132 20 VIDEO CT8
- 17133 20 VIDEO CT9
- 17134 20 VIDEO CT10
- 17135 20 VIDEO CT11
- 17136 20 VIDEO CT12
- 17137 20 VIDEO CT13
- 17138 20 VIDEO CT14
- 17139 20 VIDEO CT15
- 17140 20 VIDEO CT16
- 17141 20 VIDEO CT17
- 17142 20 VIDEO CT18
- 17143 20 VIDEO CT19
- 17144 20 VIDEO CT20
- 17145 20 VIDEO CT21
- 17146 20 VIDEO CT22
- 17147 20 VIDEO CT23
- 17148 20 VIDEO CT24
- 17149 20 VIDEO CT25
- 17150 20 VIDEO CT26
- 17151 20 VIDEO CT27
- 17152 20 VIDEO CT28
- 17153 20 VIDEO CT29
- 17154 20 VIDEO CT30
- 17155 20 VIDEO CT31
- 17156 20 VIDEO CT32
- 17157 20 VIDEO CT33
- 17158 20 VIDEO CT34
- 17159 20 VIDEO CT35
- 17160 20 VIDEO CT36
- 17161 20 VIDEO CT37
- 17162 20 VIDEO CT38
- 17163 20 VIDEO CT39
- 17164 20 VIDEO CT40
- 17165 20 VIDEO CT41
- 17166 20 VIDEO CT42
- 17167 20 VIDEO CT43
- 17168 20 VIDEO CT44
- 17169 20 VIDEO CT45
- 17170 20 VIDEO CT46
- 17171 20 VIDEO CT47
- 17172 20 VIDEO CT48
- 17173 20 VIDEO CT49
- 17174 20 VIDEO CT50
- 17175 20 VIDEO CT51
- 17176 20 VIDEO CT52
- 17177 20 VIDEO CT53
- 17178 20 VIDEO CT54
- 17179 20 VIDEO CT55
- 17180 20 VIDEO CT56
- 17181 20 VIDEO CT57
- 17182 20 VIDEO CT58
- 17183 20 VIDEO CT59
- 17184 20 VIDEO CT60
- 17185 20 VIDEO CT61
- 17186 20 VIDEO CT62
- 17187 20 VIDEO CT63
- 17188 20 VIDEO CT64
- 17189 20 VIDEO CT65
- 17190 20 VIDEO CT66
- 17191 20 VIDEO CT67
- 17192 20 VIDEO CT68
- 17193 20 VIDEO CT69
- 17194 20 VIDEO CT70
- 17195 20 VIDEO CT71
- 17196 20 VIDEO CT72
- 17197 20 VIDEO CT73
- 17198 20 VIDEO CT74
- 17199 20 VIDEO CT75
- 17200 20 VIDEO CT76
- 17201 20 VIDEO CT77
- 17202 20 VIDEO CT78
- 17203 20 VIDEO CT79
- 17204 20 VIDEO CT80
- 17205 20 VIDEO CT81
- 17206 20 VIDEO CT82
- 17207 20 VIDEO CT83
- 17208 20 VIDEO CT84
- 17209 20 VIDEO CT85
- 17210 20 VIDEO CT86
- 17211 20 VIDEO CT87
- 17212 20 VIDEO CT88
- 17213 20 VIDEO CT89
- 17214 20 VIDEO CT90
- 17215 20 VIDEO CT91
- 17216 20 VIDEO CT92
- 17217 20 VIDEO CT93
- 17218 20 VIDEO CT94
- 17219 20 VIDEO CT95
- 17220 20 VIDEO CT96
- 17221 20 VIDEO CT97
- 17222 20 VIDEO CT98
- 17223 20 VIDEO CT99
- 17224 20 VIDEO CT100

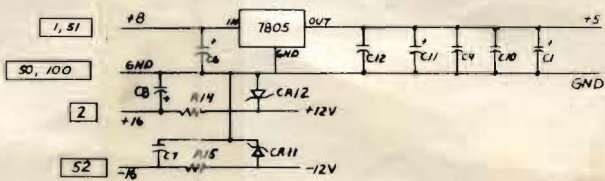

CONNECTION POINT	LOCATION
A	B8
B	C8
C	D3, E9, F1, G10
D	D3, E8
E	A9, E0
F	A9, E0
G	A9, E0
H	B11, E0
I	A4, D0
J	B4, D0
K	C7, D9, G3

TTY ACIA

VIDEO ACIA

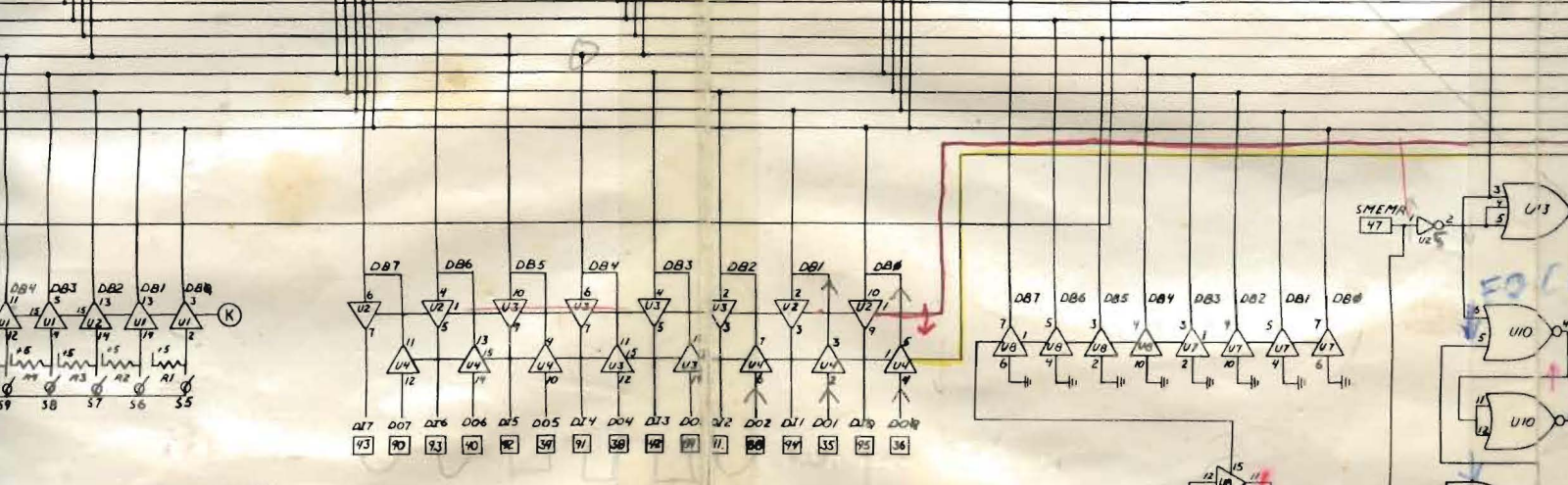
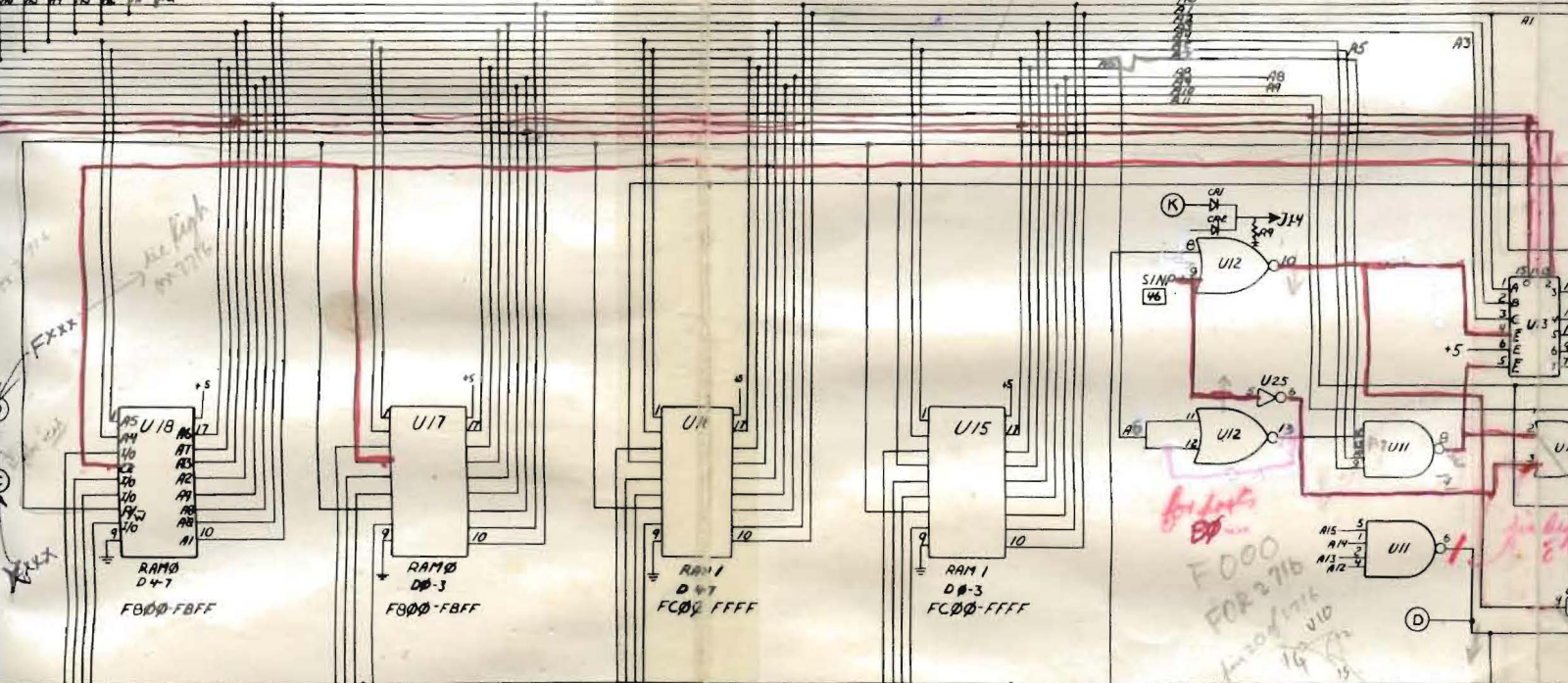
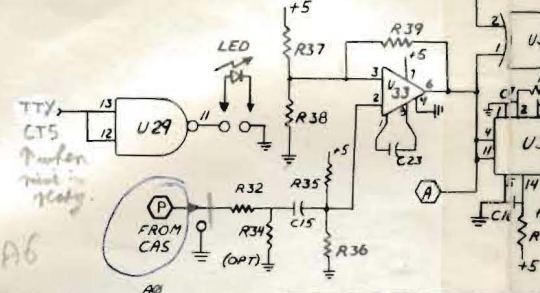
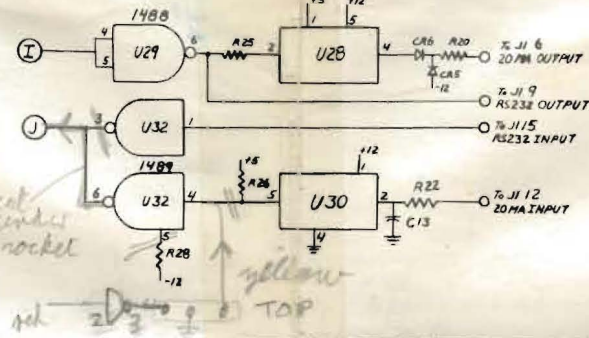
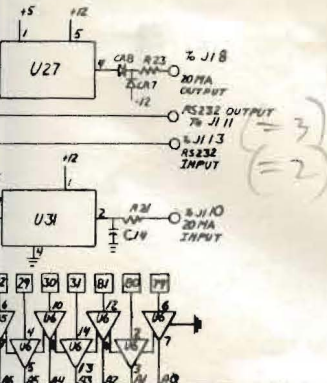

CONNECTION POINT	LOCATION
A	B8
B	C8
C	D3, E9, F1, G10
D	D3, E8
E	A9, E0
F	A9, E0
G	A9, E0
H	B11, E0
I	A4, D0
J	B4, D0
K	C7, D9, G3

NOTES:
 DB# - DATA
 DI# - DATA
 DO# - DATA
 S -

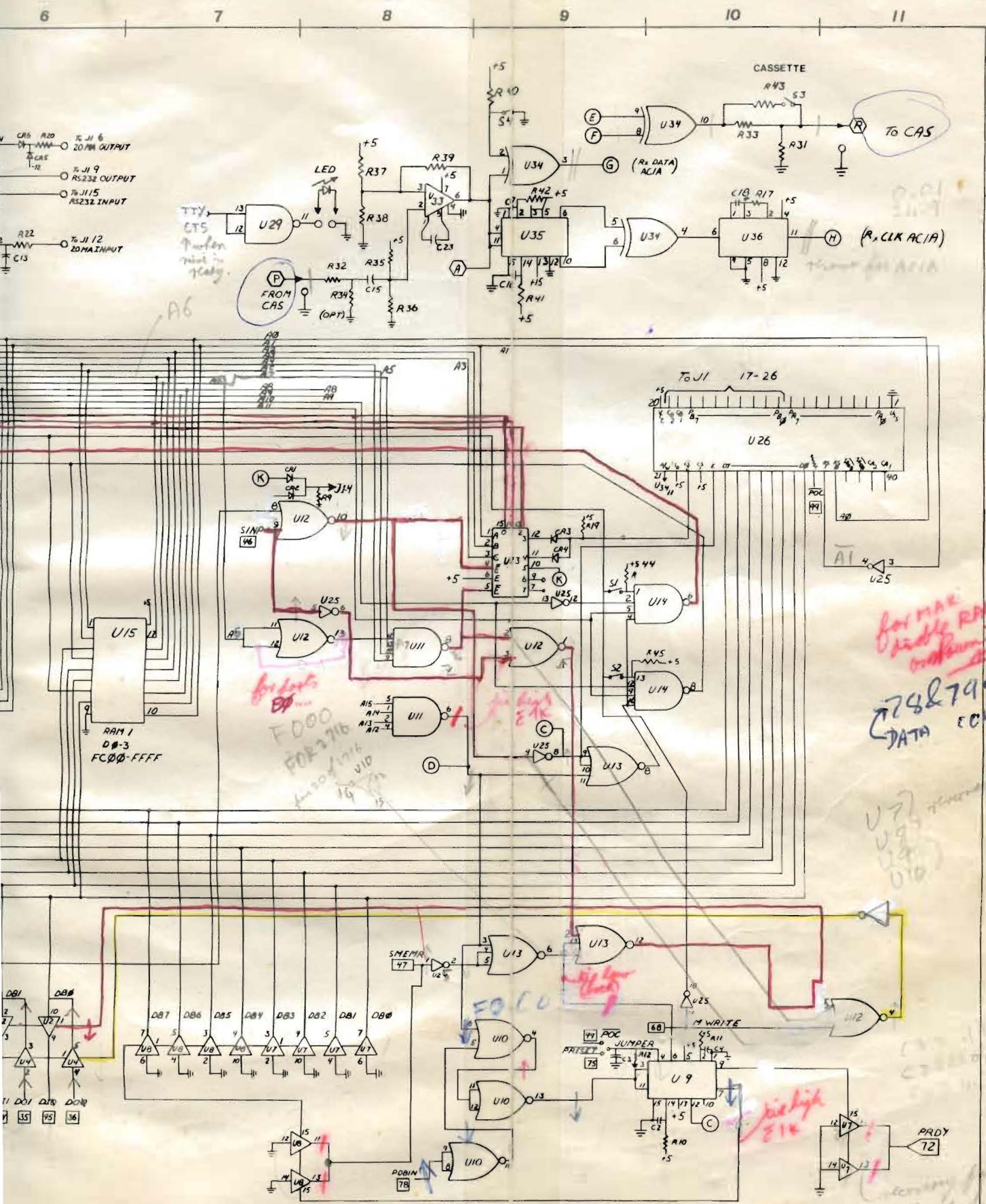

for max
stable read/write
control
78 & 79
DATA CONTROL

for data
F000
F02776
for 200/174
14 7m
14 13

NOTES:
DBA - DATA BUS OF SMB
DBP - DATA TO PROCESSOR
DOB - DATA FROM PROCESSOR
□ S - 100 BUS PIN NO.

SYSTEM MONITOR BOARD	
TECHNICAL DESIGN LABS	
REVISED 4/25/77	DWN BY JOHN D WEST
NO.	DATE 1/27/77