

PRINTER INTERFACE

© Interactive Products Corporation, 1977

PolyMorphic  
Systems



This is your PolyMorphic Systems Printer Interface Manual.

The Printer Interface mini-card allows a wide range of other peripherals to be readily attached to your POLY 88 System, ranging from slow speed hard copy terminals to high speed display terminals.



Parts Checklist

## BAG 0-101052

QUANTITY	# PER BAG	PART NUMBER	DESCRIPTION
( )	2	018008	8 Pin Socket
( )	4	018014	14 Pin Socket
( )	2	018016	16 Pin Socket
( )	1	018220	16 Pin Dip Header
( )	1	031004	SN74LS04
( )	1	031032	SN74LS32
( )	1	036080	MC1488
( )	1	036085	MC1489AL
( )	1	034297	80C97 or 34009PC
( )	2	034375	Opto-Isolator-MCT2

## BAG 1-101054

QUANTITY	# PER BAG	PART NUMBER	DESCRIPTION
( )	6	012600	Capacitor Ceramic .1mf
( )	1	017329	Hardware for AMP
( )	1	017330	AMP
( )	1	022135	In4148
( )	1	022150	IN5252
( )	1	053531	Resistor 47 ohm $\frac{1}{4}$ W 10% Carbon Com
( )	1	053547	Resistor 220 ohm $\frac{1}{4}$ W 10% Carbon Co
( )	1	053551	Resistor 330 ohm $\frac{1}{4}$ W 10% Carbon Co
( )	2	053563	Resistor 1000 ohm $\frac{1}{4}$ W 10% Carbon C
( )	2	054057	Resistor 560 ohm $\frac{1}{2}$ W 10% Carbon Co
( )	1	072200	2N5449
( )	1	079100	3M 06/06/65-15
( )	1	101053	Hardware



Parts Checklist (cont.)

## HARDWARE

QUANTITY	# PER BAG		DESCRIPTION
( )	2	_____	4.40 x 3/8" Flat Head Screws
( )	2	_____	4.40 Hex Nut
( )	2	_____	#4 Lock Washer
( )	1	_____	3' Length #20 60/40 Solder
( )	1	_____	6" Length #24 Tinned Copper Wire





## a. Assemble processor board serial option.

This option consists of a USART and associated circuits necessary for the conversion of parallel data to a serial data stream, and vice versa.

1. If you obtained the serial port option later than the processor board, you probably have not installed any of the processor board components included with the option. If this is the case, install the following sockets and components on the processor board (refer to processor board parts layout, fig. A-3, and photo of complete board following page 17):

<u>CHECK</u>	<u>SCHEMATIC #</u>	<u>TYPE</u>
( )	IC28 (socket only)	28 pin DIP socket
( )	42, 43 (sockets)	14 pin DIP socket
( )	C25, C30	0.1 $\mu$ F ceramic disc
( )	D3 (colored band points same direction as arrow)	1N4148 diode
( )	C43	10 $\mu$ F tantalum capacitor
( )	IC44	79L12 regulator

If you have a 4.0 monitor ROM install "K" jumper otherwise ignore this instruction.

( ) Install Jumper "K"

2. Now test for voltage regulation. Plug the board into a working backplane (always check to see that the power is off until the board is completely installed in the socket).

PolyMorphic Systems Printer Interface

- ( ) Check pin 12 of the ribbon cable for  $-12V \pm 0.6V$ . If the proper voltage is not present, check closely for solder bridges. Make sure this regulator is working right before proceeding.

3. Install the integrated circuits.

<u>CHECK</u>	<u>IC #</u>	<u>TYPE</u>	<u>FUNCTION</u>
( )	28	8251	USART
( )	29	MM5307	Baud rate generator
( )	31	74LS08	Quad AND gate

The processor board is now complete.

b. Assemble the serial mini-card option.

First decide whether the board will be used for RS-232C, 20ma current loop or 60ma current loop. (Note: open loop voltage of current loops must not exceed 24 volts.)

1. Install all resistors; refer to the parts layout (fig. A-5).

<u>CHECK</u>	<u>SCHEMATIC #</u>	<u>DESCRIPTION</u>
( )	R1 (20ma current loop only)	$330\Omega$ $\frac{1}{4}W$ resistor
( )	R1 (60ma current loop only)	$47\Omega$ $\frac{1}{4}W$ resistor
( )	R3	$1000\Omega$ $\frac{1}{4}W$ resistor
( )	R4	$220\Omega$ $\frac{1}{4}W$ resistor
( )	R6	$1000\Omega$ $\frac{1}{4}W$ resistor

2. Install the diodes, making sure the colored band points in the same direction as the arrow etched on the board.

<u>CHECK</u>	<u>SCHEMATIC #</u>	<u>DESCRIPTION</u>
( )	D1	1N4148 diode
( )	D2	1N5252 or 1N5254A zener diode

3. Install the DIP sockets.

<u>CHECK</u>	<u>LAYOUT POSITION #</u>	<u>DESCRIPTION</u>
( )	J1	16 pin DIP socket

PolyMorphic Systems

Printer Interface

<input type="checkbox"/>	IC1, IC2	8 pin DIP socket
<input type="checkbox"/>	IC3	14 pin DIP socket
<input type="checkbox"/>	IC4	16 pin DIP socket
<input type="checkbox"/>	IC5 through IC7	14 pin DIP socket

4. Install the capacitors.

<u>CHECK</u>	<u>LAYOUT POSITION #</u>	<u>DESCRIPTION</u>
<input type="checkbox"/>	C1 through C6	0.1 $\mu$ F ceramic disc

5. Install the transistor.

<u>CHECK</u>	<u>SCHEMATIC #</u>	<u>DESCRIPTION</u>
<input type="checkbox"/>	Q1	2N5449 NPN transistor

6. Install the connectors.

Mount the 25 pin connector on the top of the card.

It is usually necessary to use a thin, stiff tool (such as an awl or screwdriver) or needle nose pliers to align individual pins with the PC card holes. Begin at one end and work toward the other, partially inserting each pin. Do not force the connector into position; it should slide into place with slight pressure if all 25 pins are oriented properly. Fasten the connector to the card with 4-40 screws, nuts, and lockwashers. Solder the pins.

Orient the card so that the words "Serial I/O" are along the bottom edge. Orient the ribbon cable so that it runs left to right with the one colored wire (usually red) at the top. Insert the left ribbon cable plug into the card from the top. Pin 1 will be in the upper left, and the wires will enter the card from the right. Solder the 14 pins. For future reference, note that pin 1 of the unsoldered DIP plug is on the side nearest the colored wire.

7.  Check carefully for solder bridges, unsoldered joints, and cold solder joints.

8. Install the integrated circuits. Note: the ICs marked with an asterisk (\*) are MOS, and can sometimes be damaged by the

voltage present on your hands. Do not touch the pins on these chips any more than absolutely necessary. Install only the ICs used for your application.

FOR RS-232C APPLICATIONS

<u>CHECK</u>	<u>SCHEMATIC #</u>		<u>DESCRIPTION</u>
( )	IC3	74LS32	2 input OR gate
( )	IC4*	80C97 or 4503	Tri-state buffer
( )	IC5	1488	TTL to RS-232 interface
( )	IC6	1489A	RS-232 to TTL interface
( )	IC7	74LS04	Inverter

FOR CURRENT LOOP APPLICATIONS

<u>CHECK</u>	<u>SCHEMATIC #</u>		<u>DESCRIPTION</u>
( )	IC1	TIL116, MCT2, or 4N28	Opto-isolator*
( )	IC2	TIL116, MCT2, or 4N28	Opto-isolator*
( )	IC3	74LS32	2 input OR gate
( )	IC4*	80C97 or 4503 or 340097	Tri-state buffer
( )	IC7	74LS04	Inverter

Device Address Selection

Note the circled jumper pads in the  $\emptyset/1$  area on figure A5. The  $\emptyset/1$  jumper selects the device number assigned to this serial card. The serial I/O card is usually installed as device 1 when running a printer.

( ) If the jumper is connected between the lower hole and the  $\emptyset$  hole directly above it, port  $\emptyset$  is selected. ( ) If the lower hole is connected to the 1 hole above it and to the left, port 1 is selected. (Note that the lower left hole next to this area is not a jumper connection.)

The serial card is enabled by setting data bit 5 (D5 of bits D $\emptyset$  through D7) of output port 4 to the same value as the jumper-selected port,  $\emptyset$  or 1.

\* Note these chips have 6 pins and are put at the top of the 8 pin sockets.

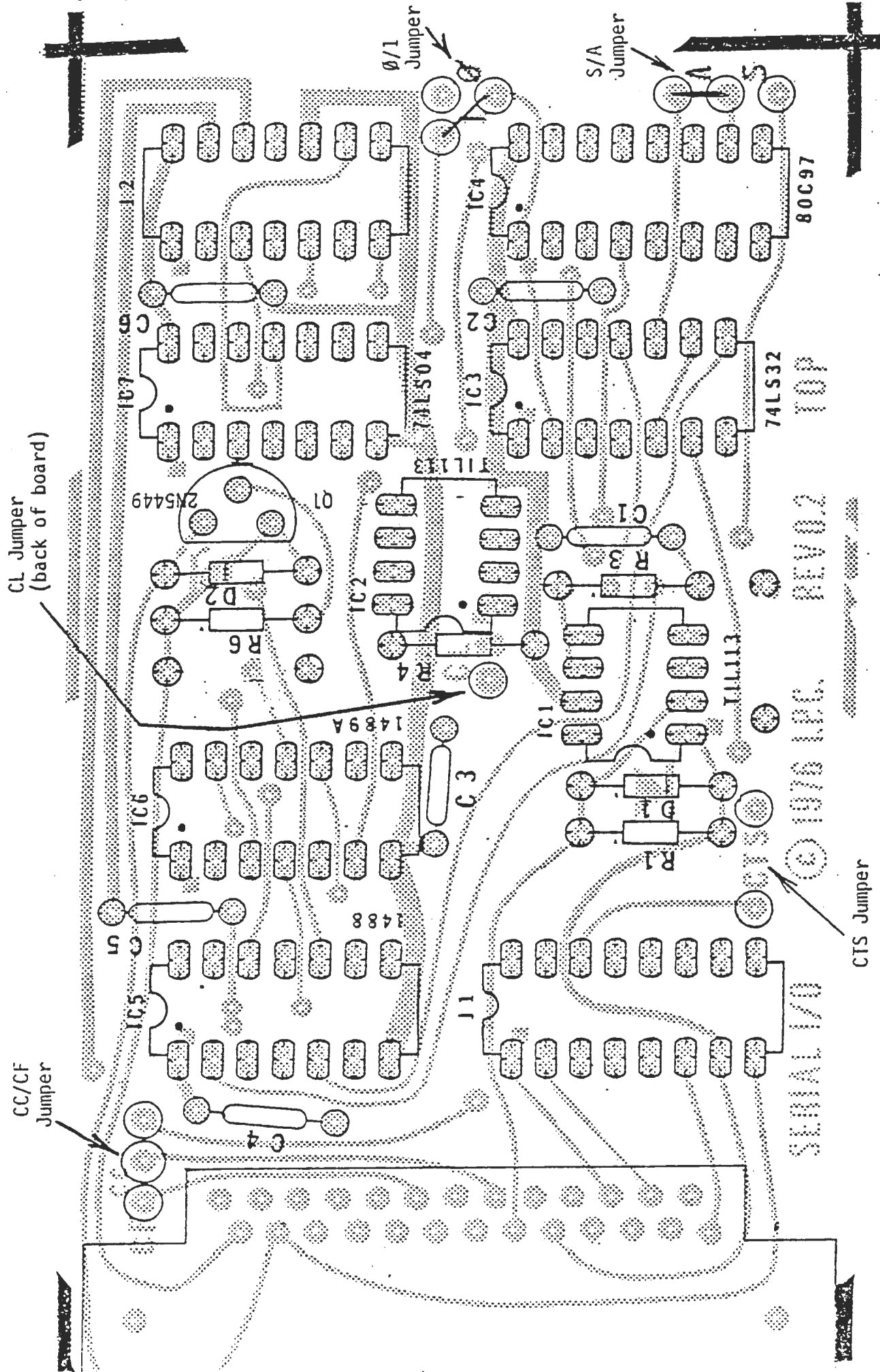

Figure A-5

9. The jumpers installed in this section select RS-232 or current loop operation (and variations of these). Section 9A describes current loop configuration and 9B the RS-232 configuration.

9A. Current loop configuration

( ) Note the circled pads in the S/A area on figure A-5. Install a wire jumper from the middle hole to the bottom hole (A)\*

( ) Note the CL area in figure A-5. These two pads must be jumpered together. One pad is concealed by R4; jumper on the back of the board.

( ) Install a jumper from pin 6 to pin 7 of IC6. The jumper may be soldered to these pins on the back of the board or inserted into the IC socket (soldering is preferred).

( ) Note the CTS area on the figure. Jumper the two pads in this area together.

( ) Wire the DIP plug with a single wire from pin 3 to pin 14 (as shown below) and insert into J1.

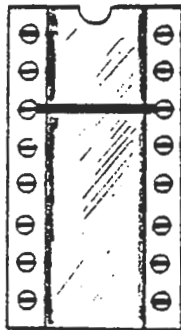

This completes the current loop wiring.

9B. RS-232 configuration

( ) Note the circled pads in the S/A area on figure A-5. Install a wire jumper from the middle hole to the bottom hole (S).

\* Hole A is the top hole on the diagram

10. Test

PRINTER INTERFACE  
Jumper Connections

Temporarily wire a header according to the drawings below for your type of interface and install on the board.

CURRENT LOOP

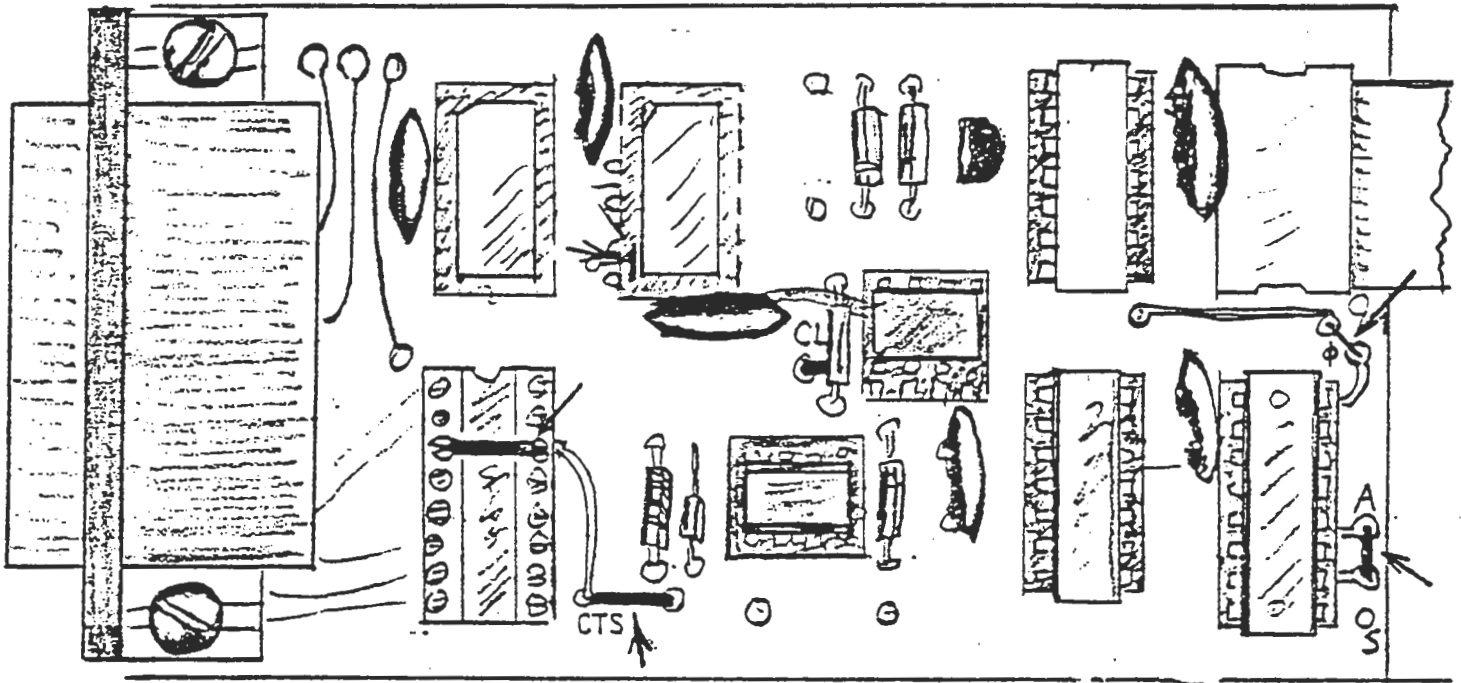

RS-232

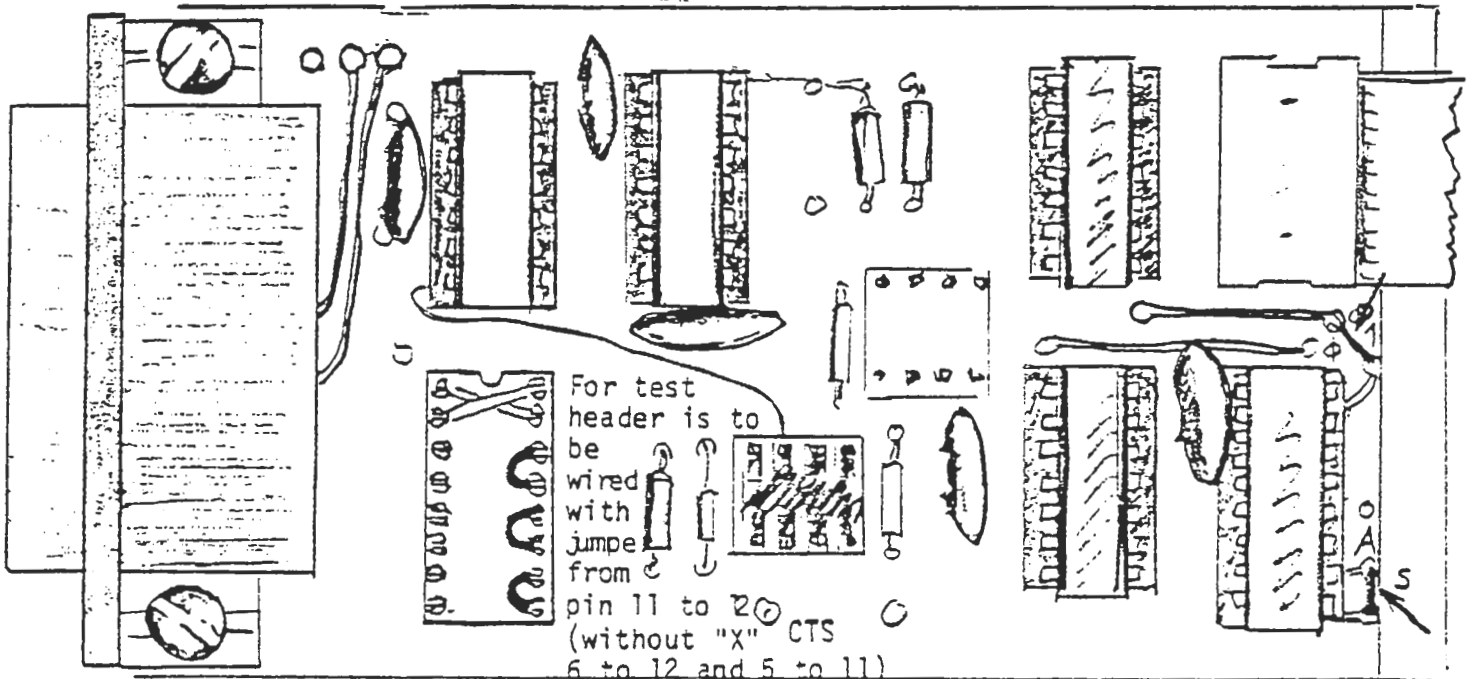

Before mounting the serial option card on the back panel, check to see that it is operating correctly. Attach the ribbon cable from the mini-card to the processor board, making sure that pin 1 is down.

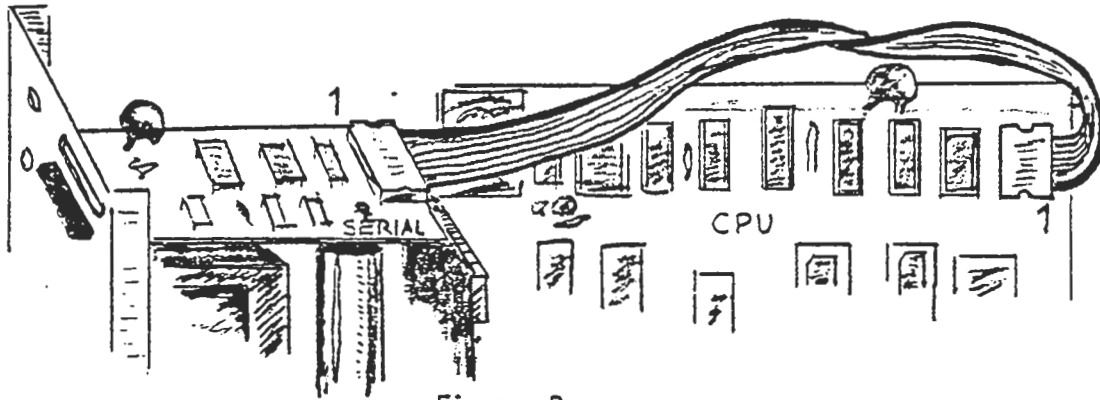

Figure D

Note that there are two output port connectors on the upper right corner of the processor board, connected in parallel. The serial option can be plugged into either port. Pre-bend the ribbon cable to clear the small components on the end of the board.

For current loop connect:

( ) a 560 ohm resistor from pin 5 to pin 17; ( ) connect pins 19 and 24 together ( ) and 25 and 7 together.

Type in the following test program beginning at 0C80H. If you have a cassette board, save the program on cassette so it may be reloaded easily.



```

;
; ***** SERIAL I/O TEST PROGRAM *****
;
; This program initializes the USART for 9600 baud
; (asynchronous) and sends characters to itself.
;
;
; Equates for 4.0 monitor
;
0064      IORET      EQU      0064H      ;ISR return
00B8      ERROR     EQU      10111000B  ;error mask
02AD      SETUP     EQU      02ADH      ;USART setup routine
0000      DAT       EQU      0          ;USART data port
0001      STAT      EQU      1          ;USART status/command port
0001      TBE       EQU      1          ;USART TX buffer empty flag
0002      RBF       EQU      2          ;USART RX buffer full flag
0392      CLEAR     EQU      0392H      ;sends form feed
039C      TABBER    EQU      039CH      ;sends horizontal tab
03D1      DEOUT     EQU      03D1H      ;puts 4-digit hex. number on sci
0C16      SRA4      EQU      0C16H      ;USART service routine entry
0C20      WH0       EQU      0C20H      ;Console In routine
0C24      WH1       EQU      0C24H      ;Console Out routine
;
0C80      ;          ORG      0C80H      ;first available RAM
;
0C80 210000  START:  LXI      H,0          ;zero error counter
0C83 22F40C          SHLD     EC
0C86 F3          LOOP:  DI
0C87 21CE0C          LXI      H,ISR      ;enter new service routine
0C8A 22160C          SHLD     SRA4      ;into ISR table
0C8D CDAD02          CALL    SETUP     ;setup USART
0C90 1FAA405E        DB      1FH,0AAH,40H,5EH,10,0
0C94 0A00          ;9600 baud, async. 8-bits w/ odd parity
;
0C96 FB          EI          ;enable interrupts
0C97 3E27          MVI      A,27H      ;turn on USART
0C99 D301          OUT      STAT
0C9B 0C          LOOP1: INR      C          ;wait 1/2 sec.
0C9C C29B0C          JNZ     LOOP1
0C9F 04          INR      B
0CA0 C29B0C          JNZ     LOOP1
0CA3 CD9203          CALL    CLEAR     ;clear screen
0CA6 2AF20C          LHLD    CTR          ;get character count
0CA9 EB          XCHG
0CAA CDD103          CALL    DEOUT     ;display count
0CAD 210000          LXI      H,0          ;clear counter
0CB0 22F20C          SHLD    CTR
0CB3 CD9C03          CALL    TABBER
0CB6 2AF40C          LHLD    EC          ;increment error counter
0CB9 EB          XCHG
0CBA CDD103          CALL    DEOUT     ;display count
0CBD DB01          IN      STAT
0CBF EE00          XRI      80H          ;invert DSR flag
0CC1 E6B8          ANI      ERROR      ;any errors?

```

```
0CC3 CA860C      JZ      LOOP      ;if 0, loop back
0CC6 13          INX      D        ;if errors,
0CC7 EB          XCHG     ;increment error counter
0CC8 22F40C      SHLD    EC
0CCB C3860C      JMP     LOOP

;
;Interrupt service routine
;
0CCE DB01      ISR:    IN      STAT    ;get status
0CD0 E602      ANI     RBF     ;receiver full?
0CD2 C2E60C      JNZ     READ
0CD5 DB01      IN      STAT
0CD7 E601      ANI     TBE     ;transmitter empty?
0CD9 CA6400      JZ      IORET    ;spurious interrupt
0CDC 21F60C      WRITE:  LXI    H,CH  ;increment character
0CDF 34          INR     M
0CE0 7E          MOV     A,M
0CE1 D300      OUT     DAT      ;send it
0CE3 C36400      JMP     IORET
0CE6 DB00      READ:   IN      DAT      ;get character
0CE8 2AF20C      LHLD   CTR      ;increment character count
0CEB 23          INX     H
0CEC 22F20C      SHLD   CTR
0CEF C36400      JMP     IORET

;
;TEMP. STORAGE
;
0CF2          CTR:   DS     2      ;char. ctr.
0CF4          EC:    DS     2      ;error ctr.
0CF6          CH:    DS     1      ;character to transmit
;
0000          END
```

To test an RS-232 configuration connect pins together on RS-232 plug as follows:

	<u>pin</u>	<u>to</u>	<u>pin</u>
( )	2		3
( )	4		5
( )	6		20
( )	17		24

and plug into serial board under test.

Execute the program at 0C80H. The display will blank and 2 four digit hex numbers will appear in the upper left hand corner of the screen. The first number is the count of characters transmitted through the USART (should be approx. 260 to 280). The 2nd number is the error count and should be zero (0). If it is not the data being transmitted thru the serial board and back to the USART is in error. If the 1st number is zero no data at all is getting thru.

This program outputs data to the serial port at 9600 baud, then reads it back in and checks for parity errors. If there are no errors, (second number on the screen is zero) and data is getting through (first number on the screen greater than 260) your printer interface is working. If not procede with the troubleshooting section.

### 11. Trouble Shooting

If your board does not work turn off the power and check that all the chips are in their proper places. Are the 1488 and 1489 in correctly?\* It's easy to switch them accidentally. Is the header in upside down? Make sure all the jumpers are correctly installed.

If all these things check out, turn the power back on and start the program again (you will have to reload it). Check to see that all the power supplies are getting to the board. (± 12, +5). The power can be checked on the ribbon cable connector. Be sure not to skip this step. 90% of all problems are caused by faulty power supplies.

If all the power supplies check out correctly, check to see that the board is selected. This can be done by checking with a logic probe on Pin 1 of the 80C97. A logical "0" indicates the board is selected.

If all these things check out, start tracing signals along the data and\*\* control paths. This can be done with a logic probe for the most part, but do not attempt to use it at the output of the 1488, or input of the 1489, or the current loop output or input lines as it is not designed for these voltages. To check these points use a voltmeter. When using the voltmeter, check for DC on the control lines, and AC on the signal lines. The outputs of the 1488 sing from plus/to minus 12 volts and are inverting, so be careful you do not over-range your meter. Similar caution should be used when checking the current loop operation.

\*(RS-232 only)

\*\*Refer to section #13 Theory of Operation

Now connect up to the external serial device you intend to use. Perform the step below that conforms to your application.

( ) RS-232: In most cases, the external device comes equipped with a mating plug. If this is so in your application, plug it into the 25 pin connector on the mini-card. If the device does not have a plug, provide one, wiring it in conformance to the RS-232 wiring chart presented earlier. RS-232 requires plug part no. DB-25P.

( ) Current loop - external current source: In most current loop applications, the external device provides a current source. If yours does not, you must make provision for a current source. (refer to the next paragraph).

Refer to the following chart of current loop pin descriptions for the 25 pin connector, and to the schematic.



The RS-232 standard was originally developed as an interface between a terminal or computer and a dataset. However, it has been extended to many other devices as well. Our terminology will define one of the interconnected devices to be a terminal device and the other to be the controlling device. For instance, the TXD line is the line over which the terminal device transmits data to the controlling device; the RXD line is the line over which the terminal device receives data. In most applications involving a system like the one we are dealing with here, the external device is the terminal and the computer itself is the controlling device. The RS-232 standard definitions for the lines between controlling and terminal devices are:

## PIN

1	protective ground	
2	TXD	Transmit data from terminal to controlling device.
3	RXD	Receive data sent from controlling device to terminal.
4	RTS	Request to send -- terminal device asks controller for permission to transmit.
5	CTS	Clear to send -- controller grants permission.
6	DSR	Data set ready -- controlling device is ready.
7	signal ground	
8	DCD	Data carrier detect -- data set indicates carrier present
9 through 16 are not used here.		
17	RXD	Receive clock -- controlling device sends clock signal to terminal.
18 and 19 not used here.		
20	DTR	Data terminal ready -- terminal device indicates it is ready.
21 through 23 are not used.		
24	TXC	Transmit clock -- terminal transmits clock signal to controlling device.
25 is not used.		

The DIP plug wiring layout depends on whether the computer is the controlling device or the terminal device and whether the device is synchronous or asynchronous.

### RTS signal

The USART must receive a clear to send signal to send characters if this is not provided by the device being interfaced the RTS and CTS signals may be tied together at pins 14 and 13 of the DIP plug.

### Clock

The USART must have a clock in order to receive data. If the clock is not sent over the device interface (it is not a synchronous device) pins 9 and 10 of the DIP plug should be wired together.

### Data Paths

Note that the data paths are interchanged (by wiring the DIP plug straight through or by wiring pin 1 to pin 15, pin 2 to pin 16, etc.) depending upon whether we are the terminal or the controller.

Following are examples of wiring for a Decwriter (300 baud serial printer), a Diablo 1620 Hytype (300 baud letter quality printer) and a 103 type dataset.

### Decwriter

This is an asynchronous device and requires no other signals than the data going to and from it. Pins 9 and 10 are shorted to connect the baud rate generator output to the USART receive clock input. Pins 13 and 14 are connected to route the request to send signal from the USART to the clear to send on the USART to enable transmitting.

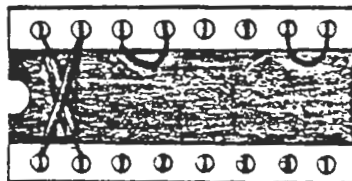



PolyMorphic Systems Printer Interface  
Diablo Hytype

The Hytype is asynchronous, but requires assertion of the clear to send and data set ready lines before it will send or receive.

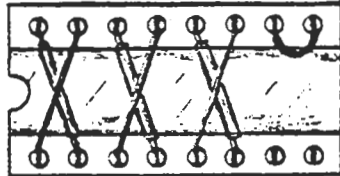

103 Modem (Data Set). The 103 Modem is also asynchronous. The data and control paths are reversed since the modem supplies the clear to send and data set ready signal to the USART (it is the controlling device).

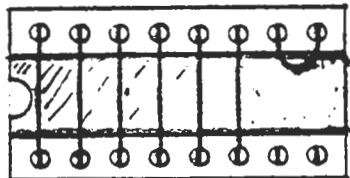

Synchronous Modem. Same as 103 Modem but must be provided with clocks.

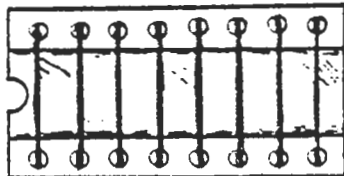

### 13. Theory of Operation

Theory of operation and schematic for the portion of the serial option installed on the processor board is covered in the discussion of the processor board.

The serial mini-card is, in essence, a level shifter. The serial port on the processor board outputs and accepts TTL level signals, while RS-232 and current loop serial devices do not.

RS-232 uses -12V low level and +12 V high level states.

ICs 5 and 6 are interface chips between TTL and RS-232 level voltages.

The current loop low level is defined as the absence of current flow. High level is the presence of flow. Opto-isolator IC2 switches the current according to the TTL level signal present at pin 1. Diode D2 limits the voltage present to 24V. On the receiving end, opto-isolator IC1 switches +5V to provide a TTL signal at pin 4.



CURRENT LOOP (INTERNAL CURRENT SOURCE)

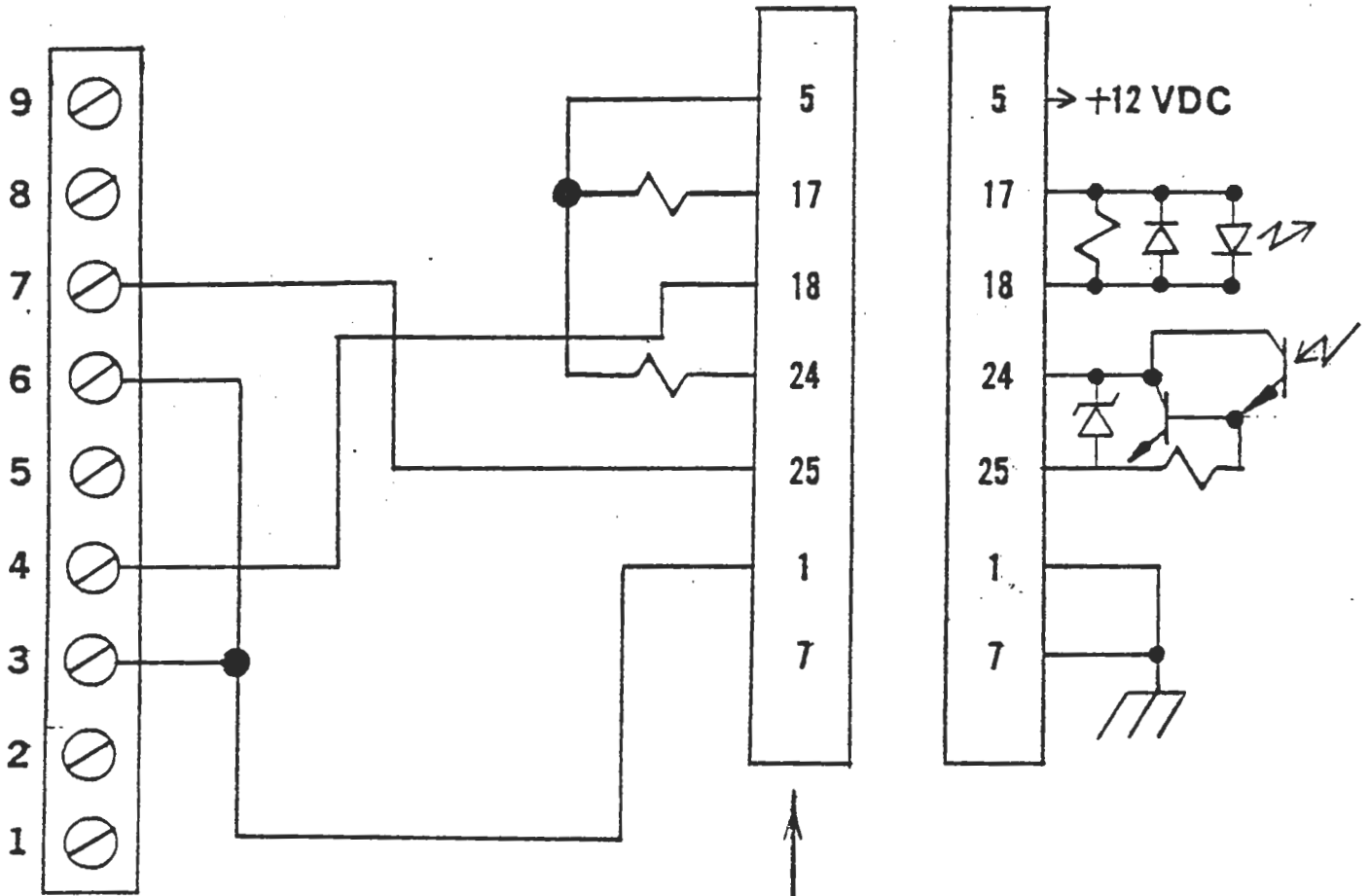

TERMINAL STRIP 151411 IN ASR/KSR-33 TELETYPE (WIRED FOR 20mA FULL DUPLEX OPERATION)\*

DB-25P (CANNON) CONNECTOR

\*SEE TELETYPE MANUAL FOR CONFIGURATION.

SERIAL I/O MINICARD  
CHIP PINOUTS

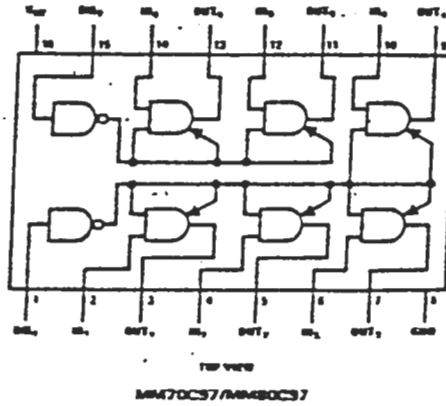

MC1488

L Suffix  
CERAMIC PACKAGE  
CASE 637  
TO-116



PIN CONNECTIONS

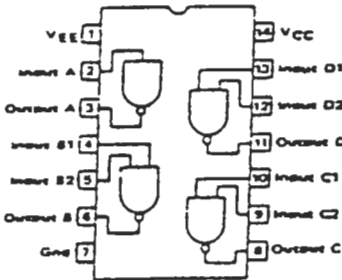

P Suffix  
PLASTIC PACKAGE  
CASE 646

MC1489AL

P SUFFIX  
PLASTIC PACKAGE  
CASE 646

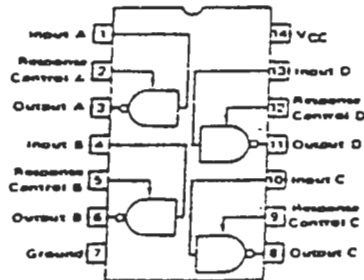

L SUFFIX  
CERAMIC PACKAGE  
CASE 637  
TO-116

TIL 116  
4N28  
MCT2

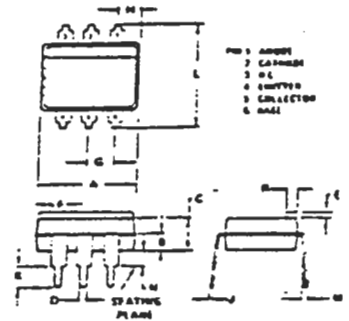

DIM	MILLIMETERS		INCHES	
	MIN	MAX	MIN	MAX
A	2.30	2.29	0.230	0.230
B	1.40	1.41	0.055	0.055
C	2.32	2.18	0.115	0.125
D	0.41	0.51	0.016	0.020
E	0.64	0.29	0.025	0.025
F	1.14	1.42	0.045	0.055
G	1.34	1.52	0.100	0.120
H	1.57	1.53	0.062	0.062
J	0.25	0.25	0.009	0.011
K	2.54	1.50	0.100	0.118
L	2.27	1.51	0.200	0.118
M	-	-	-	0.020
N	-	1.27	-	0.050
P	1.57	1.72	0.062	0.070

CASE 673-03

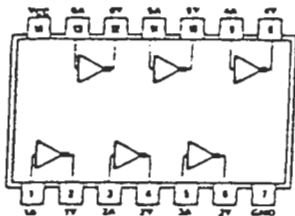

SN5404/SN7404(J, N)  
SN54M04/SN74M04(J, N)  
SN54L04/SN74L04(J, N)  
SN54LS04/SN74LS04(J, N, W)  
SN54S04/SN74S04(J, M, W)

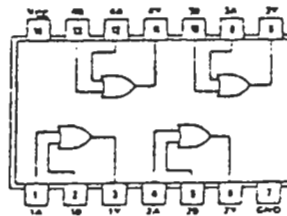

SN5432/SN7432(J, N, W)  
SN54LS32/SN74LS32(J, N, W)

